DOOR CONTROL
MODULE
CONNECTORS

molex

Introduction	3
TYPICAL NETWORK	4
KEY FACTORS	5
CUSTOMERS' GENERAL NEEDS	6
MOLEX CONNECTOR SOLUTIONS	7
CASE ANALYSIS	9

The door control module (DCM), also called a door control unit (DCU), is a type of automotive electronic that provides intelligent control for vehicle doors, and their peripheral electric parts and components, that enable features such as power windows, anti-pinch technology, central door locking, rearview mirror adjustment, door lighting and more. The increased importance of DCM/DCU is inevitable in the context of advancing automotive electronic technologies, and the widespread applications of controller area network/ local interconnect network (CAN/LIN) bus technology, that drives the development of automotive data transmission, driver and passenger safety and comfort, vehicle weight reduction and design modularity.

Localized Control

We hold the opinion that the development of DCM will result in a distributed solution, separating the door-area functions from a centralized body control module (BCM) to create more localized control functions within the door. There are three main reasons to move away from centralized BCM control:

- 1** Automotive customer requirements are increasing in the areas of vehicle handling, safety and comfort. In addition, the number of functions located within the door are growing, and integrated solutions are becoming more and more complex with declining flexibility.
- 2** The difficulty of routing wires from a BCM into the door area, and the cost of upgrading and updating a centralized BCM, increases as the number of features increases.
- 3** Distributed control from a DCM provides flexibility of both functionality and configuration, along with better interchangeability and compatibility, which are all aligned with the trends of today's driver and passenger demands.

A DCM needs circuitry for the following: power, power window drive, rearview mirror drive, heater drive, central door locking drive, lamp drive, CAN bus interface, key interface and more. These serve features such as power windows, rearview mirror folding and horizontal/vertical adjustment, electric heating and lighting. And, as functional requirements continue to increase, designs will only grow in complexity.



The development of DCM will result in a distributed solution, separating the door-area functions from a centralized body control module (BCM) to create more localized control functions within the door.

Connector Requirements for DCMs

As the market places increasing demands on DCMs, they are becoming smaller, lighter in weight and lower in cost; also, they are consuming less power. More importantly, functionality and scalability are both improving. As a result, DCMs are raising new requirements for their connectors. First, as DCM functionality is enhanced, different configurations have been adopted by different vehicle models, calling for flexible scalability:

- 1-in-1 (1 DCM per door)
- 2-in-1 (1 DCM for each side of the car)
- 4-in-1 (1 DCM per vehicle, controlling all 4 doors)

Because the mounting space for the DCM is restricted, the connector is required to have a lower and narrower profile. Also, to meet ergonomic requirements for connector operations, both the insertion and the withdrawal force must not exceed 75N.



TYPICAL NETWORK TOPOLOGY FOR DISTRIBUTED DOOR CONTROL MODULE (DCM) APPLICATIONS

Network Topology for Distributed Door Control Network (1-in-1 option)

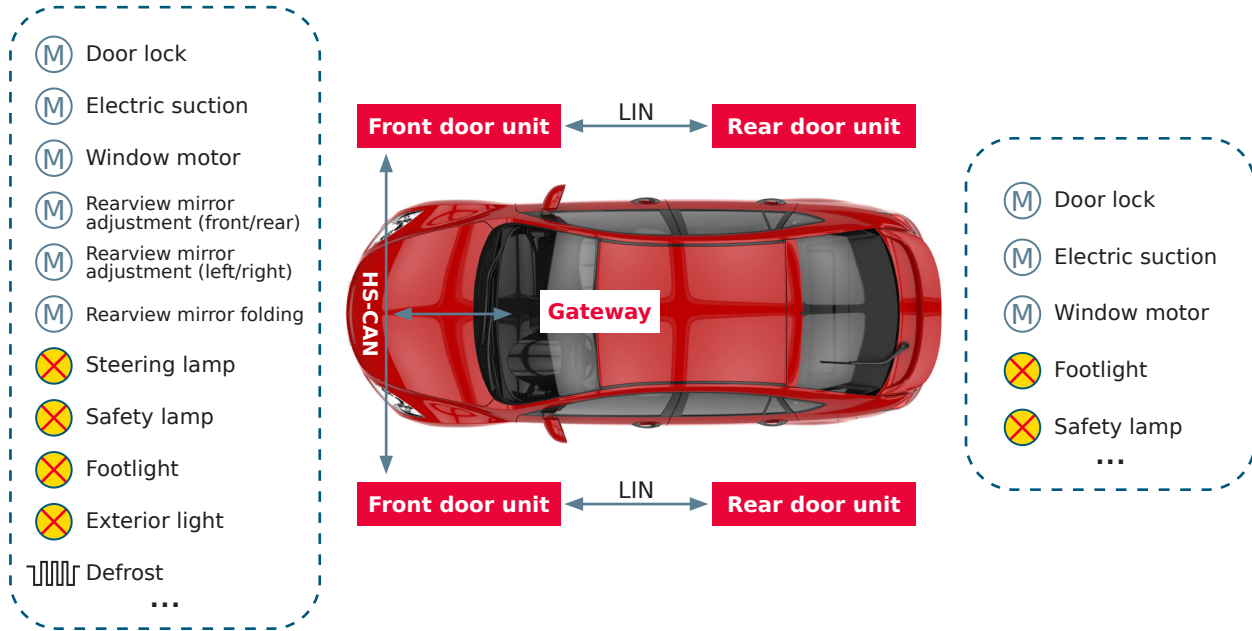

Typical Centralized Network Topology

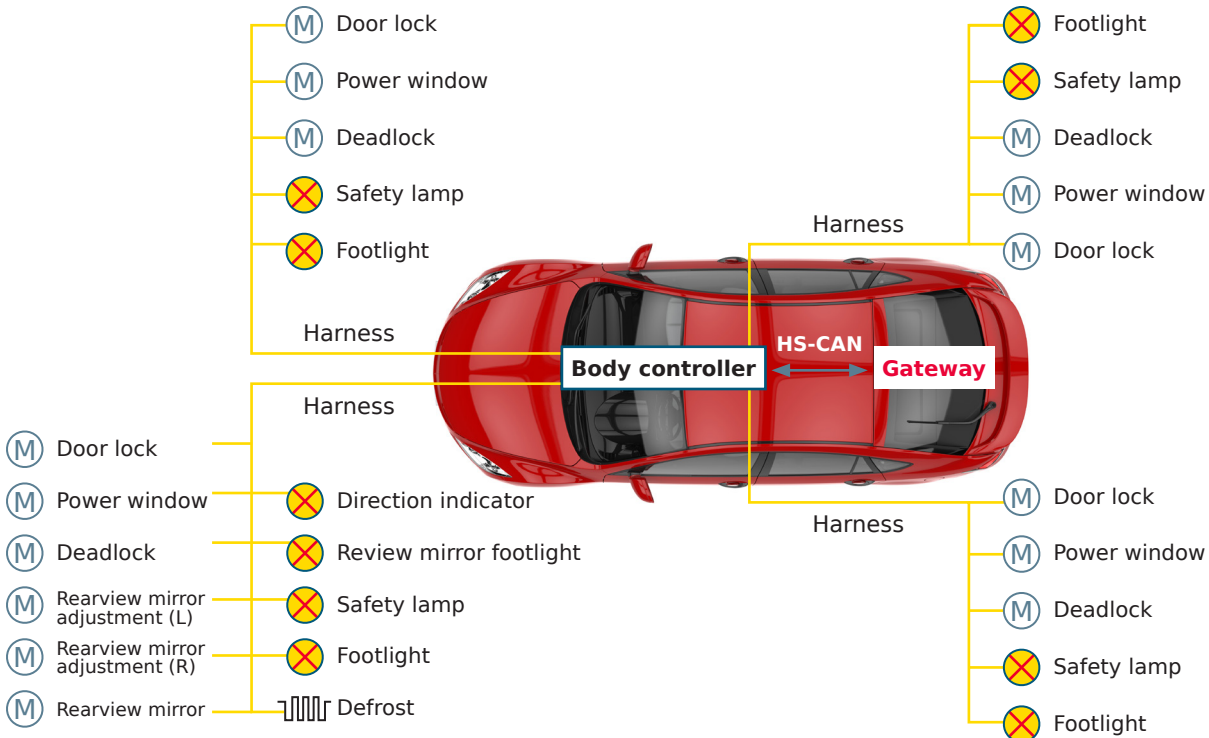



KEY FACTORS INFLUENCING THE SELECTION OF DCM CONNECTOR OPTIONS

The DCM is a key component in automobile body electronics that accomplishes the electric control for primary door functions, including door lock, rearview mirror, power windows and auxiliary lighting. The following nine factors most influence the number of DCM connector circuits required:

- 1 Number of door control motors**
Defining the configuration (i.e., 1-in-1, 2-in-1 or 4-in-1) has an immediate effect on the functional design of a DCM and the number of electric motors required.
- 2 Integration of other application functions**
Applications other than door-related functions, such as rearview mirror direction control, steering lamps and safety lighting, that may affect connector selection.
- 3 Window anti-pinch control strategy**
Power windows provide convenience but pose a safety risk as well. Therefore, “anti-pinch” control requires a proper solution. Ripple wave and Hall, for example, represent today’s mainstream technologies. OEMs choose different design directions due to the restrictions in terms of cost and assembly processes. Some incorporate the design into the power window switch, while others adopt the motor plug-in anti-pinch or integrate with the door control unit.
- 4 Design add-ins for comfort and safety features**
Some DCM design features add comfort, such as rearview mirror position memory, ambient lighting and electric suction, while others may increase safety — rearview mirror selection indicator, safety locking and super door lock are a few examples.
- 5 DCM switching signal**
The DCM needs to recognize the driver’s intention by receiving signals from the remote control central lock switch, rearview mirror control switch, position memory switch and window control switch.
- 6 CAN/LIN communication links**
The DCM normally requires one way of CAN (CAN high and CAN low) and one or two ways of LIN.
- 7 Operating temperatures**
The DCM is mounted within the cabin, with the range of operating temperatures being -40 to +85°C.
- 8 Installation location**
The DCM is in most cases mounted within the driver door with restricted space.
- 9 Cost**
The cost of a DCM is the most fundamental consideration for its product selection given the basic technical indicators guaranteed. Generally speaking, in a DCM series, more functions and more pins would translate into a greater number of interfaces, thus a greater cost.

Basic design requirements for door control modules (DCM)

- Working voltage: 9V to 16V
- Operating temperatures: -40 to +85°C
- LIN/CAN communication:
L: 19.2 kbps/C: 500kbps
- Vibration level: V1

CUSTOMERS' GENERAL NEEDS

Flexibility of options, diversity of drive strategy

A DCM can drive various power loads and transmission signals ranging from an LED requiring several milliamperes to a power window motor needing around 30.0A. The loads under the control of a typical door module ECU require different drive strategies.

- A DCM normally provides 6 to 12 2.80mm terminals for control of power supply, grounding and large loads with $I \leq 30.0A$ for a window motor, electric suction and more.
- A DCM often needs 4 to 12 1.2/1.50mm terminals for the control of small loads with $I \leq 10.0A$ for door lock motors, super lock motors, rearview mirror folding motors, outside door handle retracting motors, heater coils and more.
- A DCM often requires 30~60 0.5 or 0.64mm terminals for $I \leq 3A$ lights, LED and other small load and CAN&LIN, Hall, motor control signal transmission, and switch control.

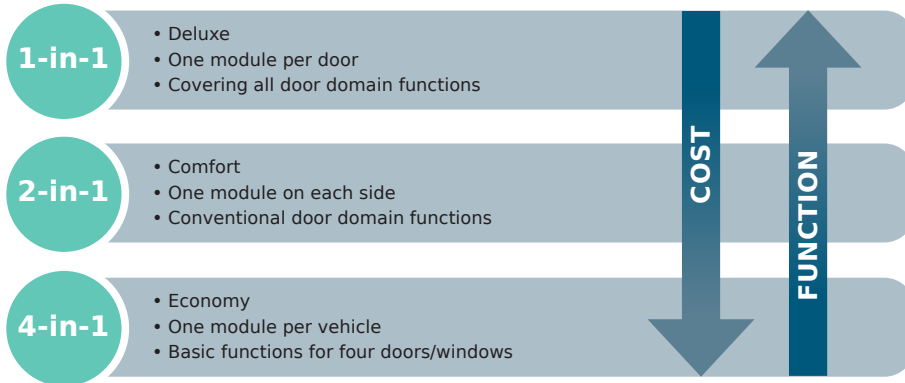

Scalable DCM functional configurations for diverse customer demands

Various classes of vehicle, such as economy, comfort and deluxe, provide different solutions based on functional requirement such as 1-in-1, 2-in-1 and 4-in-1.

- DCM circuitry normally keeps 40 to 80 pins.
 - The DCM in economy and comfort models, according to actual requirements, often offers 40 to 60 pins for the 4-in-1 solution, controlling basic functions such as the four windows, central control door locks and two rearview mirrors, while other comfort and safety features would be appropriately added or removed by specific vehicle model.
 - The DCM in deluxe models, according to actual requirements, often offers 60 to 80 pins for the 1-in-1 solution for controls over steering lamp/flash lamps, outside door lights, defrosters and even electronic dimming mirrors in addition to door locks, rearview mirrors, power windows and auxiliary lighting.
- Keeping a reasonable redundancy during DCM design, around 10% as recommended, will facilitate future functional expansion.

Other general needs due to restricted DCM mounting location

In most cases the mounting location is within the door. The module is increasingly required to be smaller due to restricted door internal space.

- Height stays at 20.00 to 40.00mm
- Length and width are normally kept within 150.00mm
- Mating/unmating force $\leq 75N$
- IP52K rating, with the connector mounted to one side of the module
- DCM connected to vehicle body/seat/instrumentation, based on functional requirements, with separate frame connector facilitating operations

Door Control Module (DCM) Connector Solutions

Molex stAK50h, Stac64 and Mini50 Connectors utilize terminal systems that have been widely accepted in the automotive industry to fulfill the functional requirements for CAN, LIN and power within one connector, achieving standardization for the connector.

STAK50H CONNECTORS

Current-carrying capability on single terminal:

- 2.80mm – maximum current: 23.0A
- 1.20mm – maximum current: 13.0A
- 0.50mm – maximum current: 3.0A

StAK50h Connector: non-waterproof, mixed pins; 12-, 25-, 27-/28- and 32-pin available on single product; splicing supported between interfaces; combination of mixed pins.

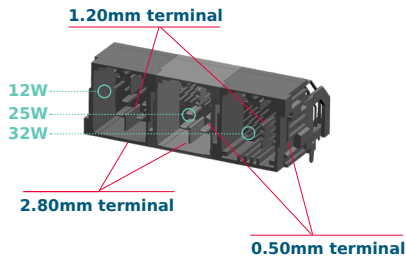

STAC64 CONNECTORS

Current-carrying capability on single terminal:

- 2.80mm – maximum current: 30.0A
- 1.50mm – maximum current: 20.0A
- 0.64mm – maximum current: 6.0A

Stac64 Connector: non-waterproof; mixed pins on 10- and 14-pin, 0.64mm terminal available on 8-, 12-, 16- and 20-pin; splicing supported between interfaces.

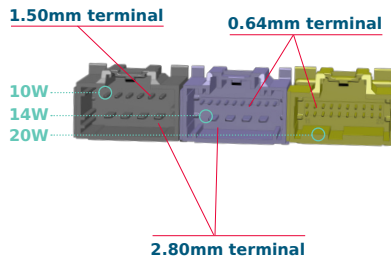

MINI50 CONNECTORS

Current-carrying capability on single terminal:

- 1.20mm – maximum current: 16.0A
- 0.50mm – maximum current: 4.0A

Mini50 Connector: 34- and 38-pin non-waterproof, mixed pins for 34-pin; splicing supported on 34- and 38-pin.

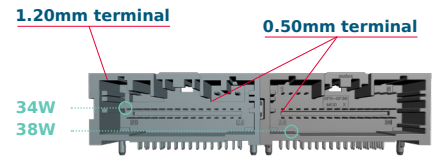

StAK50h and Mini50 Miniaturized Connectors use the smallest terminal systems in today's automotive industry

Miniaturized terminal systems with reduced connector size:

- The smallest 0.50mm terminal systems in the industry, 20% smaller than the traditional 0.64mm terminal
- Multi-row pin arrangement with smaller connector width and reduced PCB footprint
- 11.70 to 25.70mm height for low-profile version

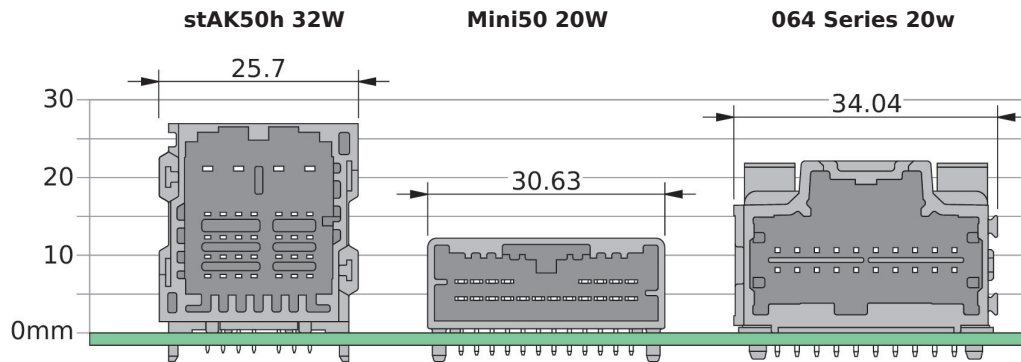

Ergonomic design with optional outgoing line directions

- Mating/unmating forces up to GMW3191, with the ergonomic design facilitating operation
- Horizontal and vertical header options that meet configuration needs for outgoing lines during installation
- Optional outlet cover available on harness end connector, for improved harness management
- Zoned harness management supported upon splicing for multiple interfaces

CASE 1: STAK50H

**StAK50h 25w+25w+27w,
77 ways in total**

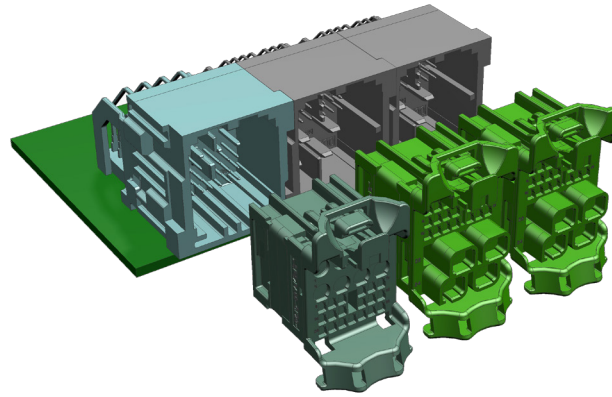

DCM CONNECTOR CASE 1	2.8mm	1.2mm	0.5mm
25w	4	/	21
25w	4	/	21
27w	/	8	19
TOTAL	8	8	61
	77 ways		

Advantages:

- Integrated, hybrid design
- Miniaturized 0.50mm terminal system
- 5-row terminal design with compact construction
- Splicing supported
- Flexibility of options

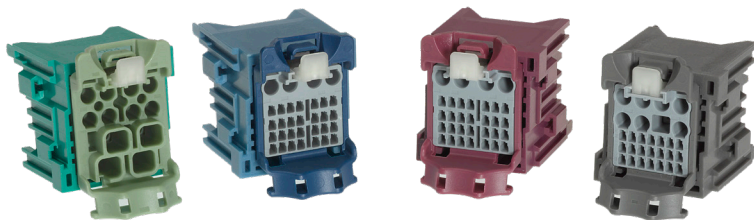

LIST OF STAK50H CONNECTOR SERIES (FREE COMBINATION UPON CUSTOMER DEMAND)

Type of StAK50h	2.8mm pin	1.2mm pin	0.5mm pin	Board connector part number		Harness end Connector Part Number
				Vertical	Horizontal	
12w	4	8	/	2005010121	2005020121	1600260001
25w	4	/	21	2005010251	2005020251	1600270011
27w	/	7	19	2005010271	2005020271	1600290011
28w	/	7	21	2005010281	2005020281	1600140011
32w	/	4	28	2005010321	2005020321	1600280011

CASE 2: STAC64+MINI50

**Stac64 10w+14w+Mini50
38w, 62 ways in total**

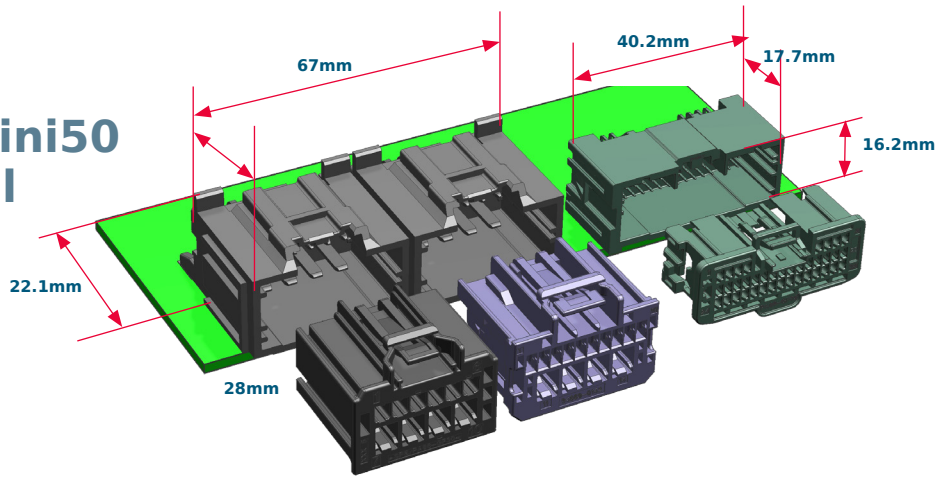

DCM CONNECTOR CASE 2	2.8mm	1.5mm	0.64mm	0.50mm
Stac64 10w	4	6	/	/
Stac64 14w	4	/	10	/
Mini50 38w	/	/	/	38
TOTAL	8	6	10	38
	62 ways			

Advantages:

- Mixed terminal design; splicing supported
- Low profile
- Miniaturized 0.50mm terminal option combined
- Superior current-carrying capability
- Flexibility of options

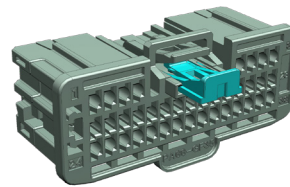
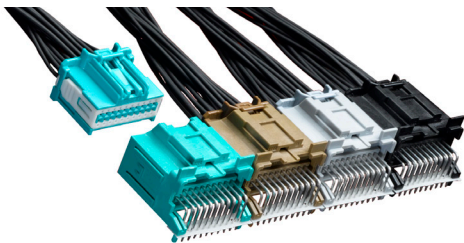

LIST OF STAC64 CONNECTOR SERIES (FREE COMBINATION UPON CUSTOMER DEMAND)

No. of ways	2.80mm pin	1.50mm pin	0.64mm pin	Board connector part number		Harness end Connector Part Number
				Vertical	Horizontal	
8w	/	/	8	34690008X	34691008X	34729008X
10w	4	6	/	34695010X	34696010X	313721X00
12w	/	/	12	34690012X	34691012X	34729012X
14w	4	/	10	34772014X	34773014X	34969014X
16w	/	/	16	34690016X	34691016X	34729016X
20w	/	/	20	34690020X	34691020X	34729020X

MINI50 CONNECTOR SYSTEM						
Series No.	Plating	Rows	Orientation	Termination Style	Circuit Sizes	
34792	Tin	Single	Vertical	Through-Hole	4, 8	
34793			Right Angle	SMT	2, 4, 8	
34912		Dual	Vertical	Through-Hole	12, 16, 20, 24	
34825			Right Angle	SMT		
34826			Three	Vertical	Through-Hole	34 Hybrid and 38
34897		Two-Bay Stacked				
34958		Gold	Single	Right Angle	SMT	68 (Hybrid-Hybrid), 72 (Hybrid-Three Row) and 76 (Three Row-Three Row)
34961			Dual			
34960		Gold	Single	Right Angle	SMT	2, 4, 8
34912-60xx			Dual			
34987					12, 16, 20, 24	

» www.molex.com

molex